

Panther Script Form

Fixed Frame Day Wheelchair 90200



To Order Fill in the frame dimensions and features required. For variations describe in detail on a separate page. If you have any further questions contact us at the address at the bottom of the page.

SEND FORM
If online, click here to send via e-mail

Date _____

Delivery details _____

Name _____

Address _____

Therapist details _____

Phone _____

Fax / Cell _____

Required by _____

Email _____

TRIAL CHAIR REF: _____

Disability _____ Weight _____ Height _____ Shoe Size _____ T-Shirt Size _____

MEASUREMENTS (Refer to diagram below)

Frame Materials

Aluminium (std) Titanium **90200T**

A Seat Width _____

F Frame Length _____

K Castor Pivot Centres _____

Ergo Seat Option **AD10220**

B Seat Length _____

G Seat to Floor - Front _____

L Footplate Width _____

N Ergo Seat Length _____

C Back Height _____

H Seat to Floor - Rear _____

M Camber (0° - 5°) _____

O Ergo Back Height _____

D Back Angle° _____

I Balance Point _____

Front Hanger Taper Style

P Ergo Back Angle° _____

E Seat to Footplate _____

J Castor Pivot Position _____

V Front Pro T Front

ADDITIONAL NOTES

(you can type here)

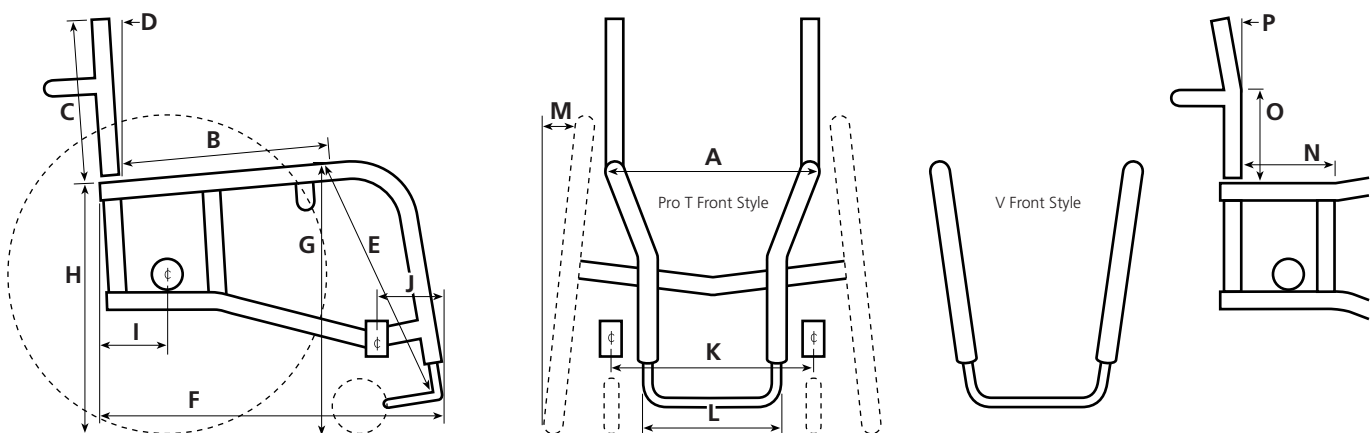

Panther Script Form

Fixed Frame Day Wheelchair

Name _____

WHEELS**24"**

- Spoked Wheels (std)
- Spinergy Day Wheels (18 spoke) **AD13300** (Choose your spoke colour) **Bk R Bl W Y**
- Spinergy LX Wheels (12 spoke) **AD13310** (Choose your spoke colour) **Bk R Bl W Y Gr Pk O**
- Spinergy LX Wheels with FlexRim (12 spoke - black only) **AD13315**
- X Core Wheels (5 spoke) **AD13108**
- Spider Wheels **AD13100**
- Topolino Wheels **AD13350**
- Dino Wheels **AD13360** (Choose your spoke colour) **Bk R Bl Sv Go Gr Pk O LB Pu**
- BMX Wheels (std)

25"

- Spoked Wheels (std)
- Spinergy Day (18 spoke) **AD13300** (Choose your spoke colour) **Bk R Bl W Y**
- Spinergy LX (12 spoke) **AD13310** (Choose your spoke colour) **Bk R Bl W Y Gr Pk O**
- Spinergy LX Wheels with FlexRim (12 spoke - black only) **AD13315**
- X Core Wheels (3 spoke) **AD13200**
- Topolino Wheels **AD13350**
- Dino Wheels **AD13360** (Choose your spoke colour) **Bk R Bl Sv Go Gr Pk O LB Pu**
- BMX Wheels (std)

26"

- Spoked Wheels (std)
- Spinergy Day (18 spoke) **AD13300** (Choose your spoke colour) **Bk R Bl W Y**
- Spinergy LX (12 spoke) **AD13310**
- BMX Wheels (std)

 Spare Wheel(s) Type: _____

Tyres: _____

Pushrims: _____

Size: _____

AXLES

- Quick release axles (std) Quad release **AD12500**

PUSHRIMS

- Anodised (std) Rubber coated (black) **AD13850** Foam **AD13840** RibGrips **AD13866**
- Anodised (1") **AD13855** Rubber coated (1") **AD13857** Natural Fit Lite **AD13860** Q Grips **AD13865**
- Vinyl **AD13830** Surge **AD13864** Max Greppe **AD13870**
- Vinyl (1") **AD13859** Surge Lite **AD13864** Spinergy FlexRim - see Wheels

PUSHRIMS - POSITION

- Standard In close Onto rim

SPOKE GUARDS



















- Nil Clear polycarb **AD13900** Black ABS **AD13901**

Panther Script Form

Fixed Frame Day Wheelchair

Name _____











COLOURS

- 27 Candy Blue 
- 1 Royal Blue 
- 72 Glass Blue 
- 16 Candy Purple 
- 48 Burgundy 
- 83 Candy Raspberry 
- 88 Fluro Pink 
- 28 Candy Red 
- 11 Flame 
- 57 Super Hot Chilli 
- 80 Candy Orange 
- 71 Pure Orange 
- 68 Crystal Yellow 
- 73 Crystal Jade 
- 89 Fluro Green 
- 70 Candy Emerald 
- 2 Hawthorn Green 
- 17 Crystal Sapphire 

ATTENTION

THIS IS A GUIDE TO COLOURS ONLY, how colours appear on your monitor or when printed out may vary.

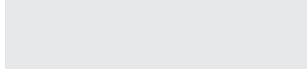
Contact us if you require assistance or a colour sample.
 This colour selection is for our aluminum frames only.
 We do not recommend powder coating titanium.
 Colour availability is subject to change without notice, contact us if you are concerned about the availability of your colour.

- 55 Silver Sparkle 
- 12 Silver Orbiter 
- 46 Chrome 
- 42 Metallic Viper 
- 30 Satin Black 
- 61 High Gloss Black 
- 62 Matt Black 
- 63 Texture Matt Black 
- 18 Clear 
- Bead Blast** (titanium only) 
- Custom Colour** (additional cost)
 Description _____